



**Prof. Surajit Dhara**

**SACT,**

**Dept. Of Physics, Narajole Raj College**

**DSE2BT( Digital, Analog Circuits and Instrumentation), Topic :- Cathode Ray Oscilloscope (CRO)**

## **The Cathode Ray Tube**

- An accelerated electron describes a portion of a cathode ray tube (CRT). This tube, is commonly used to obtain a visual display of electronic information in **oscilloscopes, radar systems, television receivers, and computer monitors.**
- The CRT is a vacuum tube in which a beam of electrons is accelerated and deflected under the influence of electric or magnetic fields. The electron beam is produced by an assembly called **an electron gun** located in the neck of the tube.
- These electrons, if left undisturbed, travel in a straight-line path until they strike the front of the CRT, the “screen,” which is coated with a material that emits visible light when bombarded with electrons.

**DSE2BT( Digital, Analog Circuits and Instrumentation), Topic :- Cathode Ray Oscilloscope**  
**: Circulated by-Prof. Surajit Dhara, Dept. Of Physics, Narajole Raj College**

## The Cathode Ray Tube

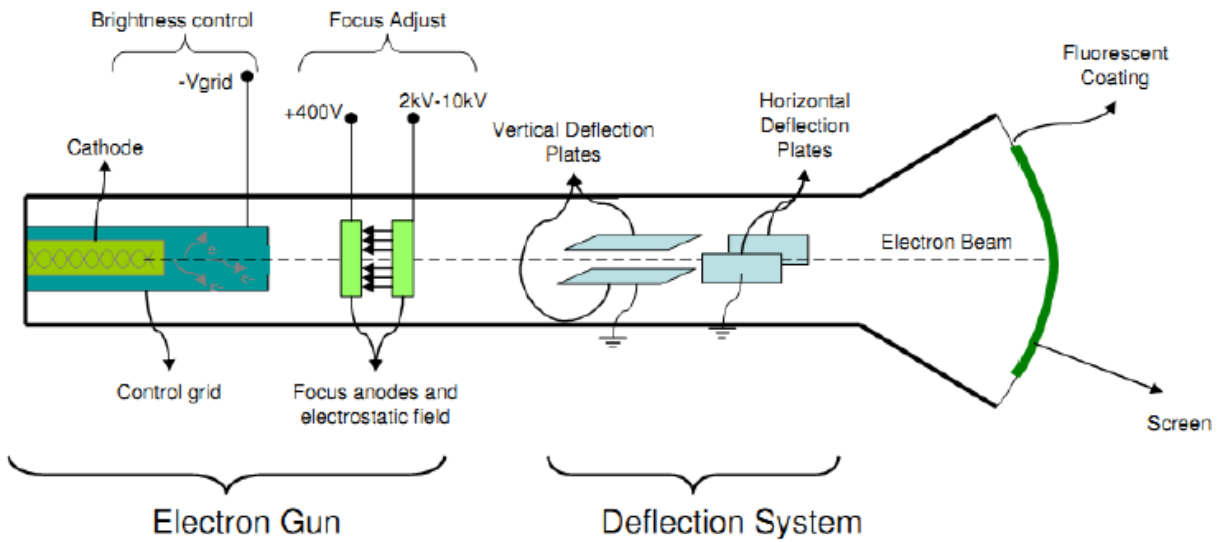

## The Cathode Ray Tube

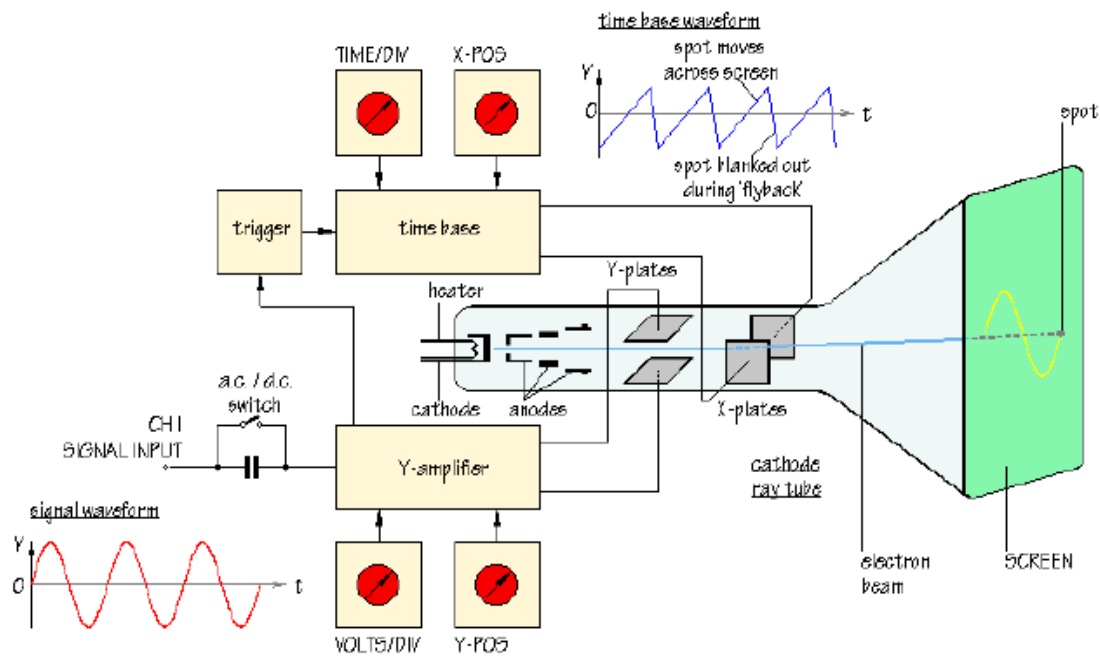

❖ The CRT is composed of two main parts,

1. Electron Gun
2. Deflection System

## ❖ **Electron Gun :**

1. Electron gun provides a sharply focused electron beam directed toward the fluorescent-coated screen.
2. The thermally heated cathode emits electrons in many directions. The control grid provides an axial direction for the electron beam and controls the number and speed of electrons in the beam.
3. The momentum of the electrons determines the intensity, or brightness, of the light emitted from the fluorescent coating due to the electron bombardment. Because electrons are negatively charged, a repulsion force is created by applying a negative voltage to the control grid, to adjust their number and speed.
4. A more negative voltage results in less number of electrons in the beam and hence decreased brightness of the beam spot. Since the electron beam consists of many electrons, the beam tends to diverge. This is because the similar (negative) charges on the electrons repulse each other. To compensate for such repulsion forces, an adjustable electrostatic field is created between two cylindrical anodes, called the focusing anodes. The variable positive voltage on the second anode cylinder is therefore used to adjust the focus or sharpness of the bright spot.

## ❖ **The Deflection System :**

The deflection system consists of two pairs of parallel plates, referred to as the vertical and horizontal deflection plates. One of the plates in each set is permanently connected to the ground (zero volt), whereas the other plate of each set is connected to input signals or triggering signal of the CRO.

## Cathode Ray Oscilloscope

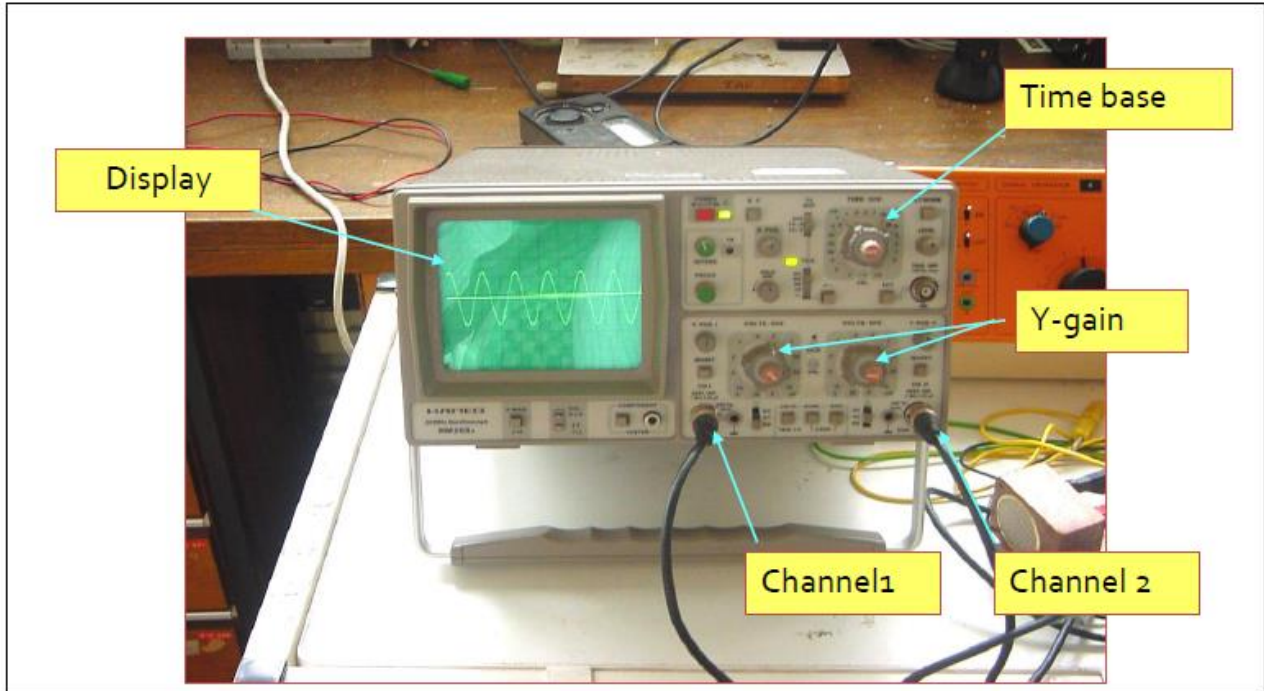

## Cathode Ray Oscilloscope Controls

### ❖ Y-Gain :

1. Amplifies the Y-deflection.
2. Small input voltages are amplified by built-in.
3. Y- Gain = 0.5 V/div.
4. 0.5 volt will cause a vertical deflection of 1 division.

### ❖ Time Base :

1. It is a *saw-tooth* voltage applied internally across the X-plates.

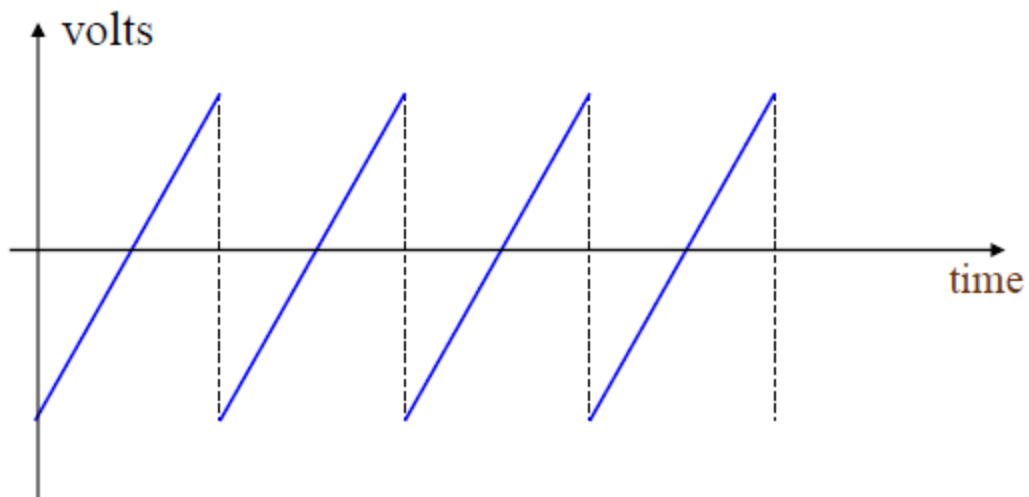

2. Controls the speed at which the spot sweeps across the screen horizontally from left to right •

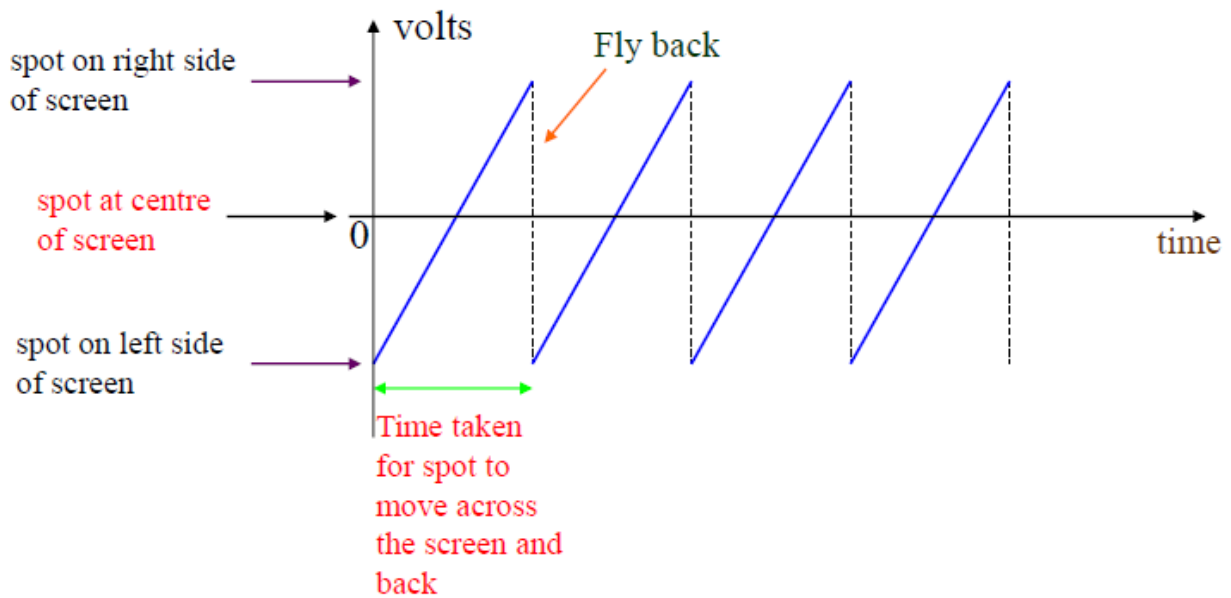

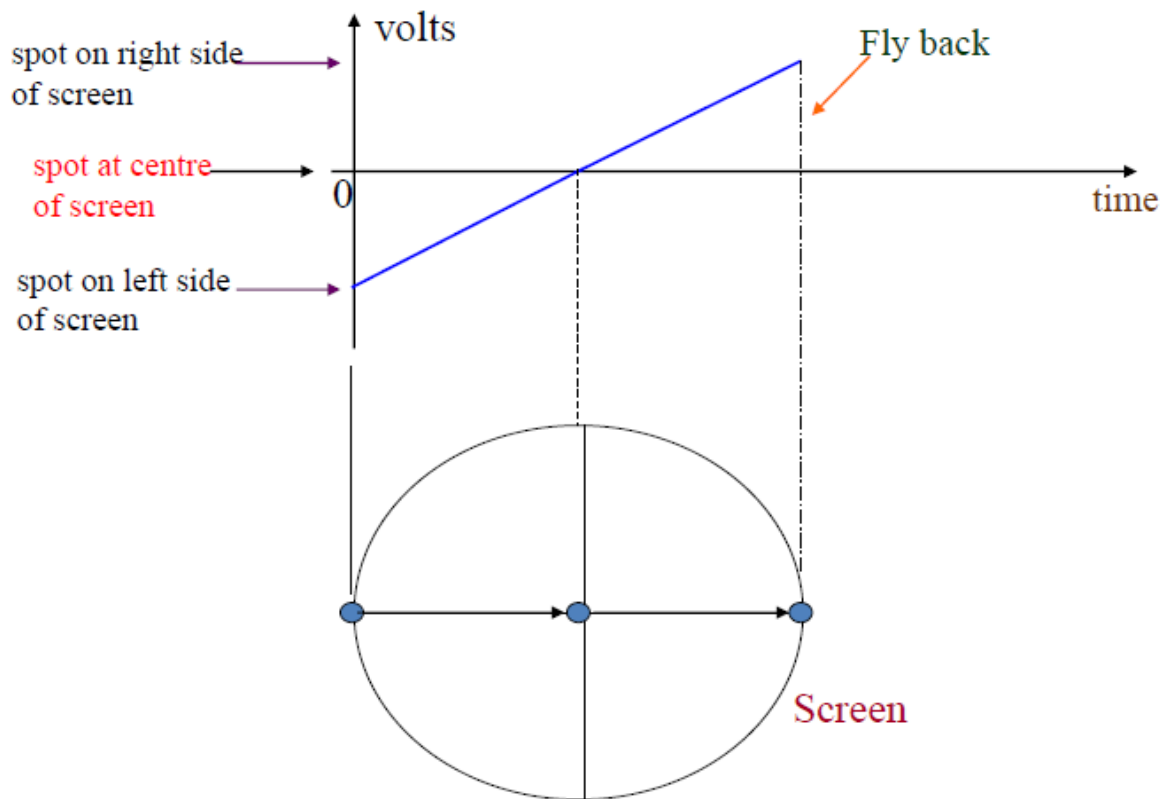

3. It helps to display the actual waveform of any a.c. applied across the Y-plates.
4. Normally calibrated in-(i) s/cm (ii) ms/cm and (iii)  $\mu\text{S}/\text{cm}$ .
5. Gives the time required for the spot to sweep 1 cm horizontally across the screen.

#### ❖ Uses of C.R.O.

1. Display waveforms of alternating p. d.
2. Measure potential difference- A.C and D.C
3. Measurement of Frequency.
4. Measurement of Phase.

# Uses of C.R.O.

## Displaying a Voltage Waveform

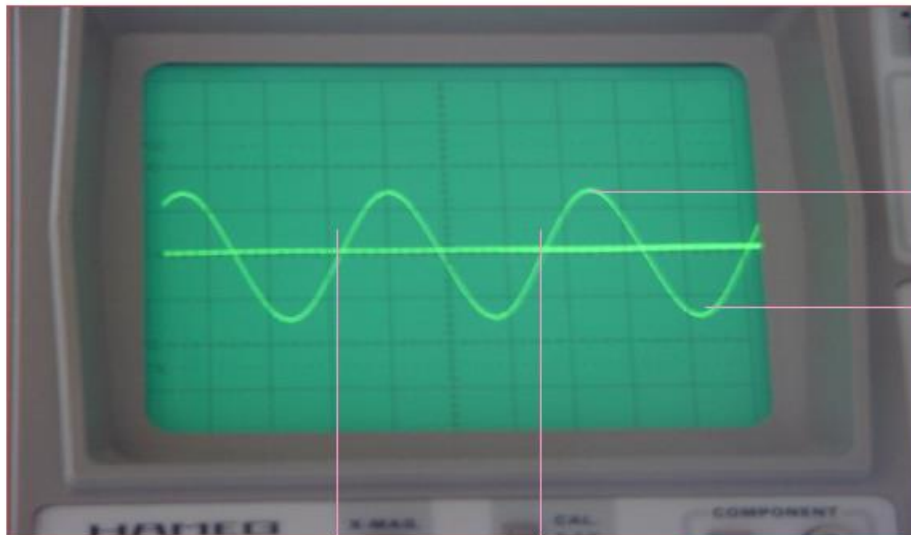

Peak-to-Peak  
voltage

Time Period (ms)

To get the time period you need to  
measure this distance and convert it  
to time by multiplying by the time  
base setting

### ❖ Displaying a Voltage Waveform :

1. Set the time-base to a suitable frequency.
2. Apply the input to the Y-plate- a steady waveform of the input will be displayed on the C.R.O.

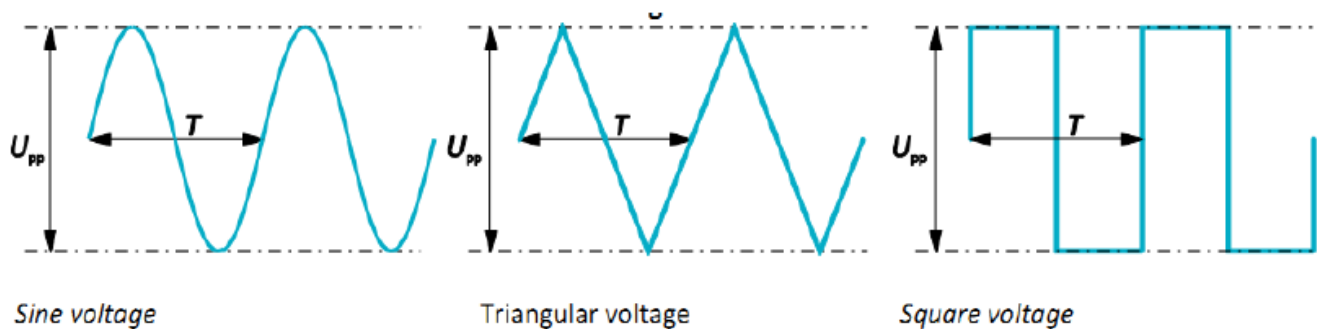



### ❖ Measuring a Direct Current Voltage :

- Switch off the time-base.
- A spot will be seen on the C.R.O. screen.
- d.c. to be measured is applied to the Y-plates.
- Spot will either deflected upwards or downwards.
- Deflection of the spot is proportional to the d.c. voltage applied.

## Measuring a Direct Current Voltage

- Set the **VOLTS/DIV to 1** by adjusting the outer dial.
- Turn the inner dial all the way to the right, which will put it in the calibrated position.
- Switch the AC-GND-DC switch for channel 1 to **DC**.

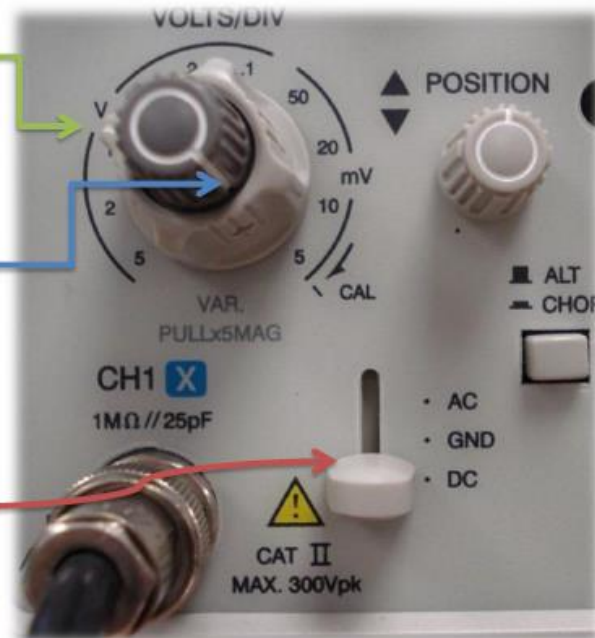

### ❖ Measurement of Frequency :

- The Time/Div dial on the oscilloscope controls the amount of time per centimeter division.
- A simple method of determining the frequency of a signal is to estimate its periodic time from the trace on the screen of a CRT.
- To calculate the frequency of the observed signal, one has to measure the period, i.e. the time taken for 1 complete cycle, using the calibrated sweep scale. The period could be calculated.
- $T = (\text{no. of squares in cm}) \times (\text{selected Time/cm scale})$ .
- Once the period T is known, the frequency is given by  $f \text{ (Hz)} = 1/T \text{ (sec)}$ .

## Example: Measurement of Frequency and a. c. voltage Using a CRO

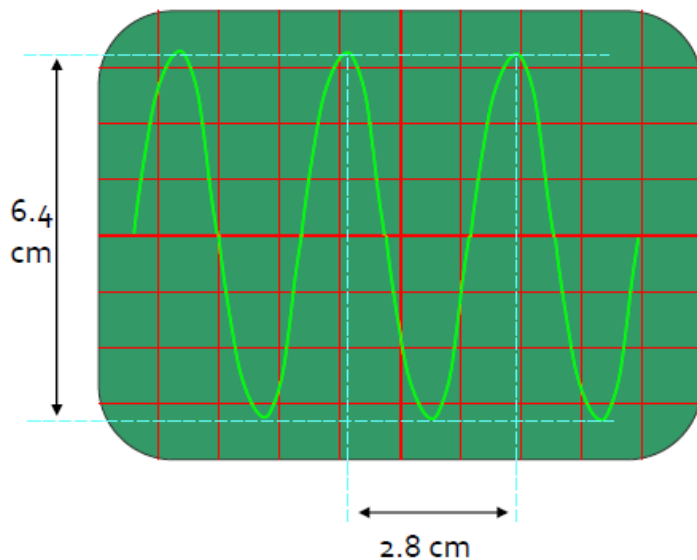

- The total height of the wave from peak to trough is 6.4 cm

$$\Rightarrow V_{pk\ to\ pk} = 12.8\ V$$

$$\Rightarrow V_o = 6.4\ V$$

- 1 cycle occupies 2.8 cm

$$\Rightarrow T = 1.40\ ms = 1.40 \times 10^{-3}\ s$$

$$\Rightarrow \text{Frequency} = 1 \div 1.40 \times 10^{-3}\ s = 714\ Hz$$

The time base controls are set at 5 ms/cm  
The voltage gain is set at 2 V/cm

### ❖ Measurement of Phase :

- The calibrated time scales can be used to calculate the phase shift between two sinusoidal signals of the same frequency. If a dual trace or beam CRO is available to display the two signals simultaneously ( one of the signals is used for synchronization), both of the signals will appear in proper time perspective and the amount of time difference between the waveforms can be measured.
- This, in turn can be utilized to calculate the phase angle , between the two signals.

$$\theta = \frac{\text{Phase Shift in cm}}{\text{One Period in cm}} \times 360^\circ$$

# Measurement of Phase

