



COMPILED & CIRCULATED BY

Dr. Tapanendu Kamilya

Assistant Professor, Department of Physics, Narajole Raj College

Topic:

Digital Circuits: Difference between Analog and Digital Circuits. Binary Numbers. Decimal to Binary and Binary to Decimal Conversion. BCD, Octal and Hexadecimal numbers. AND, OR Gates (realization using Diodes).

Digital Circuits (1):

Difference between Analog and Digital Circuits:

Analog means “continuous”. The analog circuits function on the continuous variable signals. It is typically termed as Analog signal. Digital means “discrete”. Digital circuits perform on discretely variable signals which are typically termed as digital signals. In the digital signal, there are only two state, one is low/off /0-state and the other is high/on/1-state.

Analog circuits are difficult to design, whereas, the design of digital circuits are relatively easier than analog circuits.

The analog circuits can accept the all the analog data of physical world. On the other hand, digital circuits can accept only the digital data. Therefore, digital circuits cannot accept the data from the physical world. Before accepting the data can be converted into digital signal only.

The designing of analog circuit is expensive whereas designing of digital circuit is less expensive.

The accuracy and precession of digital circuits are better than analog circuit.

Analog circuits are complex and large space are needed. Whereas, the digital circuits are simple and needed low space.

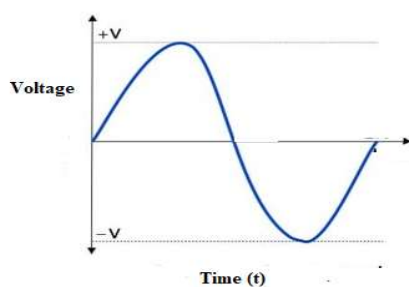

ANALOG CIRCUIT

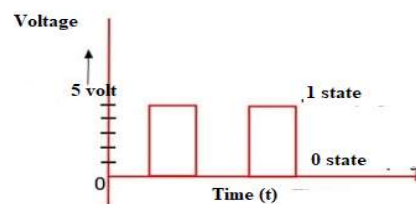

DIGITAL CIRCUIT

ry and Binary to Decimal Conversion:



COMPILED & CIRCULATED BY

Dr. Tapanendu Kamilya

Assistant Professor, Department of Physics, Narajole Raj College

Each of the binary digit 0 or 1 is called a bit. A group of bits is called byte.

Decimal to Binary:

Decimal integer number:

We first do the successive division of decimal integer number by 2 until the remainder comes to 0. Then we take the remainders in reverse order for the formation of binary number.

Decimal to Binary		Remainder
2	62	0
2	31	1
2	15	1
2	7	1
2	3	1
	1	

$$(62)_{10} = (111110)_2$$

Conversion of decimal fraction 0.375 into equivalent binary:

$$0.3750 \times 2 = 0.7500 = 0.7500 \text{ plus a carry } 0$$

$$0.7500 \times 2 = 1.5000 = 0.5000 \text{ plus a carry } 1$$

$$0.5000 \times 2 = 1.0000 = 0 \text{ plus a carry } 1$$

$$(0.3750)_{10} = (.011)_2$$

$$(62.3750)_{10} = (111110.011)_2$$

Conversion of binary into equivalent decimal



COMPILED & CIRCULATED BY

Dr. Tapanendu Kamilya

Assistant Professor, Department of Physics, Narajole Raj College

$$111110.011 = 1 \times 2^5 + 1 \times 2^4 + 1 \times 2^3 + 1 \times 2^2 + 1 \times 2^1 + 0 \times 2^0 + 0 \times 2^{-1} + 1 \times 2^{-2} + 1 \times 2^{-3}$$

Therefore, $(111110.011)_2 = (62.3750)_{10}$

BCD

In computing and electronic systems of digital displays of electronic voltmeter, multimeter, binary-coded decimal (BCD) is a technique of binary encodings of decimal numbers wherever each digit is signified by a fixed number of bits, typically four. The typically BCD code is weighted 8421 code. The four bit weight ($2^3, 2^2, 2^1, 2^0$) or (8, 4, 2, 1). By using this code we can write the number 563 in the form of-

5	6	3
↓	↓	↓
0101	0110	0011

Binary Addition

- 0 + 0 = 0
 - 0 + 1 = 1
 - 1 + 0 = 0
 - 1 + 1 = 10
 - 10 + 1 = 11
 - 11 + 1 = 100
 - 100 + 1 = 101
 - 101 + 1 = 110
 - 110 + 1 = 111
 - 111 + 1 = 1000
-

$$\begin{array}{r} 110 \\ + 101 \\ \hline \end{array}$$

1011 *Binary Addition*}

Octal Number System



COMPILED & CIRCULATED BY

Dr. Tapanendu Kamilya

Assistant Professor, Department of Physics, Narajole Raj College

Octal number system is a base eight system. The digits are 0, 1, 2, 3, 4, 5, 6, 7. The conversion of decimal to octal or octal to decimal is similar to decimal to binary and binary to decimal. However, we the division/multiplication will be done 8 in the place of 2.

Conversion of Decimal to Octal Number System

Conversion of $(200.22)_{10}$ in octal

$$\begin{array}{r|l} 8 & 200 \\ \hline 8 & 25 \quad - \quad 0 \\ & 3 \quad - \quad 1 \end{array}$$

$$(200)_{10} = (310)_8$$

$$0.22 \times 8 = 1.76 \text{ plus a carry } 1$$

$$0.76 \times 8 = 6.08 = 0.08 \text{ plus a carry } 6$$

$$0.08 \times 8 = 0.64 \text{ plus a carry } 0$$

$$0.064 \times 8 = 0.512 = 0.12 \text{ plus a carry } 5$$

$$0.12 \times 8 = 0.96 \text{ plus a carry } 0$$

$$(0.22)_{10} = (0.16050)_8$$

Therefore,

$$(200.22)_{10} = (310.16050)_8$$

Conversion of Octal to Decimal Number System

$$(310.16050)_8$$

$$3 \times 8^2 + 1 \times 8^1 + 0 \times 8^0 + 1 \times 8^{-1} + 6 \times 8^{-2} + 0 \times 8^{-3} + 5 \times 8^{-4} + 0 \times 8^{-5}$$

Hexadecimal Number System



COMPILED & CIRCULATED BY Dr. Tapanendu Kamilya

Assistant Professor, Department of Physics, Narajole Raj College

Hexadecimal number system is a base sixteen system. The digits are 0, 1, 2, 3, 4, 5, 6, 7, 8, 9, A, B, C, D, E, F. The conversion of decimal to hexadecimal or hexadecimal to decimal is similar to decimal to binary and binary to decimal. However, the division/multiplication will be done 16 in the place of 2.

Conversion of $(3502.625)_{10}$ into Hexadecimal

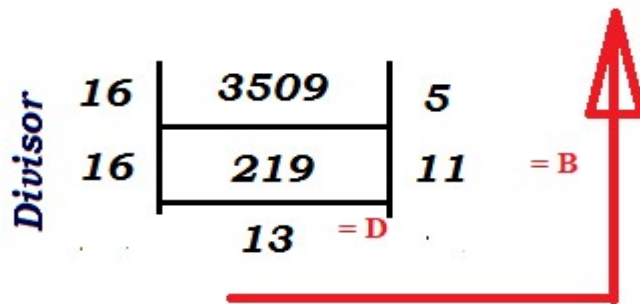

Here $13 = D$ and $11 = B$

Therefore, $(3502)_{10} = (DB5)_{16}$

Conversion of $(0.625)_{10}$ into hexadecimal

$0.625 \times 16 = 10.000 = 0$ plus a carry 10 (in Hexadecimal number A)

Therefore, $(3502.625)_{10} = (DB5.A)_{16}$

Conversion of Hexadecimal $(DA5.A)_{16}$ to Decimal Number System

$$13 \times 16^2 + 11 \times 16^1 + 5 \times 16^0 + 10 \times 16^{-1} = (3502.625)_{10}$$

OR, AND, NOT GATE:

OR- GATE		
Inputs		Output
A	B	Y
0	0	0
0	1	1
1	0	1
1	1	1

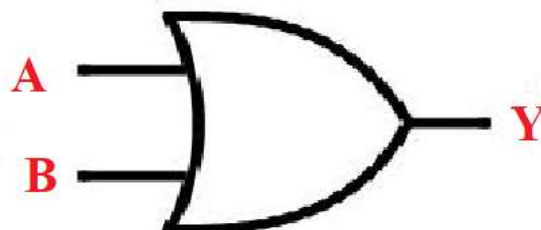



Symbol of OR Gate:

Operation of OR Gate

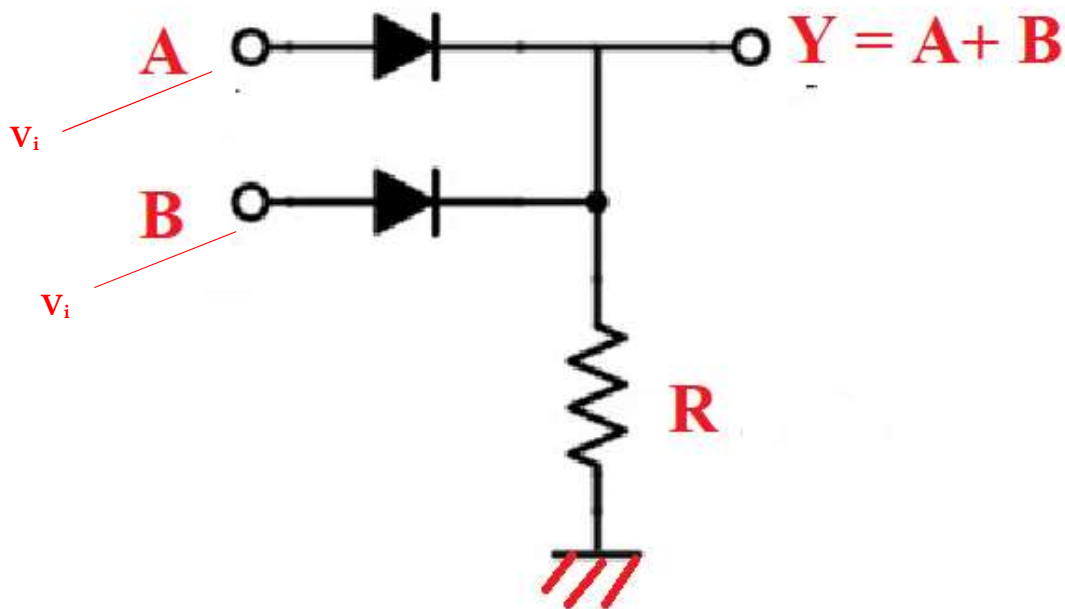

The circuit realization of 2-input OR Gate using the positive diode logic can be explained as follows:

- (i) When $A=0$ and $B=0$, i.e. both the inputs are zero. None of the diodes are conducts. Therefore, no current passes through R and Y the output becomes 0.
- (ii) When $A=1$ and $B=0$, i.e. the diode connected to A becomes forward bias and current passes through R and Y the output becomes $V_0 = \frac{V_i - V_f}{R + R_f}$. Therefore, the output becomes 1 state. Here, the diode connected to the B is non-conducting.
- (iii) When $A=0$ and $B=1$, i.e. the diode connected to B becomes forward bias and current passes through R and Y the output becomes $V_0 = \frac{V_i - V_f}{R + R_f}$. Therefore, the output becomes 1 state. Here, the diode connected to the A is non-conducting.
- (iv) When $A=1$ and $B=1$, i.e. the both the diode becomes forward bias and current passes through R and Y the output becomes $V_0 = \frac{V_i - V_f}{R + R_f}$. Therefore, the output becomes 1 state.



COMPILED & CIRCULATED BY
Dr. Tapanendu Kamilya
Assistant Professor, Department of Physics, Narajole Raj College

AND- GATE		
Inputs		Output
A	B	Y
0	0	0
0	1	0
1	0	0
1	1	1

Symbol of AND Gate:

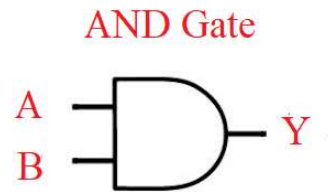

Realization of AND Gate

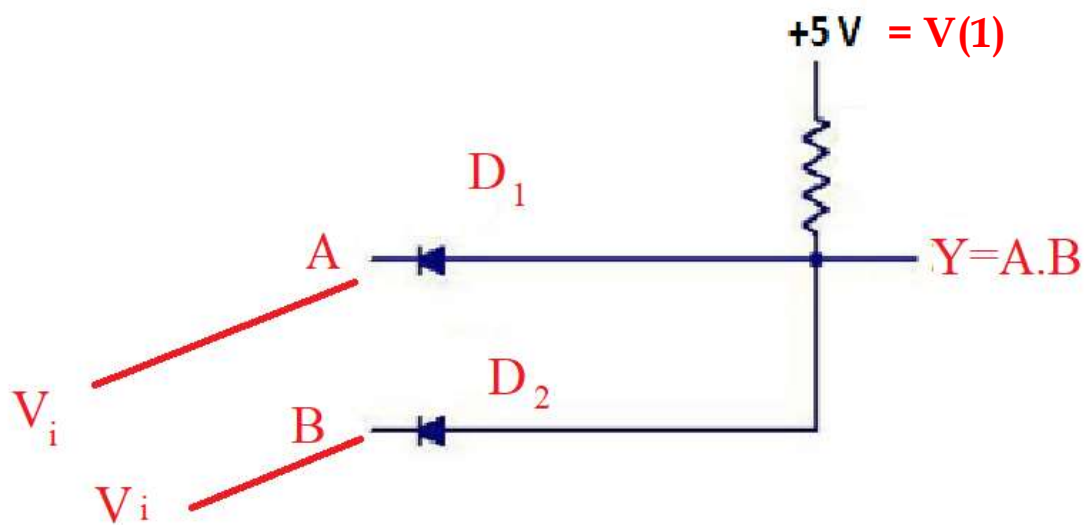



COMPILED & CIRCULATED BY

Dr. Tapanendu Kamilya

Assistant Professor, Department of Physics, Narajole Raj College

The circuit realization of 2-input AND Gate using the positive diode logic can be explained as follows:

- (i) When $A=0$ and $B=0$, i.e. both the inputs are zero. Both the diodes are conducts. Therefore, current passes through R and Y the output becomes approximately equal to the cut in voltage V_γ . Therefore, $A=0, B=0, Y=0$
- (ii) When $A=1$ and $B=0$, i.e. the diode D_2 becomes forward bias and current passes through R and Y the output becomes approximately equal to the cut in voltage V_γ . Therefore, $A=1, B=0, Y=0$
- (iii) When $A=0$ and $B=1$, the diode D_1 becomes forward bias and current passes through R and Y the output becomes approximately equal to the cut in voltage V_γ . Therefore, $A=0, B=1, Y=0$
- (iv) When $A=1$ and $B=1$, i.e. the both the inputs are high. The all diodes becomes reverse biased. No current flows through the circuit and no voltage drop through R and Y becomes equal to the V_1 . Therefore, the output becomes 1 state. Therefore, $A=1, B=1$, and we get $Y=1$.

Frequently Asked Questions:

1. What are the difference between Analog and Digital circuits?
2. Convert decimal to binary: 0.45, 25, 0.675, 13.75, 45.625
3. Convert binary to decimal: 11001.1011, 101101.101, 1101.11
4. What do you mean by BCD?
5. Convert decimal to octal: 175.22, , 320.89, 365
6. Convert octal to decimal: 257.5, 0.1605
7. Convert decimal to hexadecimal: 423.625
8. Convert hexadecimal to decimal: 1A72F, 37A.1E
9. With proper circuit diagram and truth table explain the operation of OR Gate with diode logic.
10. With proper circuit diagram and truth table explain the operation of AND Gate with diode logic.
11. Conversion of hexadecimal to binary and hexadecimal to octal also to binary to hexadecimal and octal to hexadecimal.

References:

- (i) *Fundamentals Principles of Electronics, Author: B. Ghosh, Published by Allied Pvt. Ltd. (2018 Ed.)*
- (ii) *Electronics: Fundamentals and Applications, Author- D. Chattopaddhayay and P. C. Rakshit, Published by New Age International Publishing (2018 Ed.).*
- (iii) *Electronic Principles- Author- A. Malvino, D. J. Bates, Published by Mc Graw Hill. (7th Ed.).*
- (iv) *Modern Digital Electronics- Author- R.P. Jain, Published by Mc Graw Hill. (4th Ed.).*
- (v) *Principles of Electronics- Author- V.K. Meheta, R. K. Mehata Published by S. Chand. (11th Ed.).*



COMPILED & CIRCULATED BY
Dr. Tapanendu Kamilya
Assistant Professor, Department of Physics, Narajole Raj College

Link to Audio visual Lectures (e-Lectures) and NPTEL lectures on this topic given by Distinguish Professors of Indian & Foreign Universities:

- (1) <https://nptel.ac.in/courses/117/106/117106086/>
- (2) <https://nptel.ac.in/courses/108/105/108105113/>
- (3) <https://nptel.ac.in/courses/106/105/106105185/>
- (4) <https://nptel.ac.in/courses/108/105/108105132/>
- (5) https://onlinecourses.nptel.ac.in/noc20_ee70/preview
- (6) <https://www.youtube.com/watch?v=sUutDs7FFeA>